

PREMIER

THE ORIGINAL SOURCE / THE ORIGINAL DESIGN

Hydraulic Earth Auger Attachments

Product Specifications



www.premierauger.com

November 2010

There's no better choice



Well known as the original source of the “In-Line Drive Design”, Premier Auger has built the most reliable earth auger attachments for over 3 decades. With a complete and comprehensive line of drive units, auger bits, adapters, extensions, teeth and accessories, and availability in virtually any size or model you will ever need, you can always have the right combination for maximum productivity year after year.



PREMIER POWER

Torques for virtually any digging application.

■ Premier Hydraulic Earth Auger Drive Units are designed to utilize the power of the host machine most efficiently, turning it into a high performance drilling machine. Without leaving the vehicle seat, an equipment operator can dig hundreds of holes daily in the toughest digging conditions for fence posts, sign posts, post frame buildings, foundation footings, light and utility poles and many other applications that require vertical or angled holes in the ground.

PREMIER VERSATILITY

Complete line of Drive Units, Auger Bits, Adapters, Extensions, Teeth, and Accessories.

■ Premier Earth Auger Attachments are easily adapted to skid steer loaders, wheel loaders, tractors, mini-skids, backhoes, excavators, forklifts, cranes, digger derricks, mini-digger derricks, and other hydraulic machines.

POWERFUL, VERSATILE AND RELIABLE EARTH AUGER ATTACHMENTS BACKED BY THE BEST

than Premier.

PREMIER SERVICE

Best lead times in the industry.

■ No matter how unique your digging application may be, it's our job to provide the solution when you need it.

PREMIER WARRANTY

We stand behind our quality statement.

■ Premier Auger takes great pride in the quality and reliability of our products. To reassure you that you are buying the best, we offer the best warranties in the industry and stand behind each quality statement.



TABLE OF CONTENTS

HYDRAULIC EARTH AUGER DRIVE UNITS.....	3 - 4
CONSTRUCTION AUGERS	5
TREE AUGERS.....	5
ROCK AUGERS	6
UTILITY STYLE AUGERS	6
MINI-SKID AUGER DRIVES	7
MINI-SKID CONSTRUCTION AUGERS	7
MOUNTING BRACKETS	8
MOUNTING ADAPTERS.....	8
AUGER EXTENSIONS	9
DRIVE UNIT ADAPTERS	9
HOSES & FITTINGS	10
TEETH & POINTS.....	10
AUGER COLLARS	10
REPLACEMENT WEAR PARTS	10
SELECTING COMPLETE UNIT	10

LEAD TIMES AND WARRANTIES IN THE INDUSTRY.

PREMIER 
THE ORIGINAL SOURCE / THE ORIGINAL DESIGN

Premier Hydraulic Earth Auger Drive Units easily adapt to the full range of equipment...

Skid Steer Loaders • Compact Excavators • Tractors • Telehandlers

PLANETARY AUGER DRIVE UNITS

**Mounting
Brackets,
Hose Kits and
Couplers
Listed on
Pages 8 - 10**

H005PD	
Max. Auger Diameter	12"
Min. Hydraulic GPM	5 gpm
Max. Hydraulic GPM	10 gpm
Max. Hydraulic PSI	3500 psi
5 Year Warranty	
<u>GPM - RPM</u>	<u>PSI - TORQUE</u>
5.....	62 2500
7.....	86 3000
8.....	98 3500
10.....	123 868

H010PD	
Max. Auger Diameter	24"
Min. Hydraulic GPM	6 gpm
Max. Hydraulic GPM	15 gpm
Max. Hydraulic PSI	3500 psi
5 Year Warranty	
<u>GPM - RPM</u>	<u>PSI - TORQUE</u>
8.....	48 2500
10.....	60 3000
12.....	72 3500
15.....	90 1783

H015PD	
Max. Auger Diameter	30"
Min. Hydraulic GPM	10 gpm
Max. Hydraulic GPM	25 gpm
Max. Hydraulic PSI	3500 psi
5 Year Warranty	
<u>GPM - RPM</u>	<u>PSI - TORQUE</u>
12.....	47 2500
15.....	58 3000
17.....	66 3500
20.....	78 2768

H019PD	
Max. Auger Diameter	36"
Min. Hydraulic GPM	15 gpm
Max. Hydraulic GPM	30 gpm
Max. Hydraulic PSI	3500 psi
5 Year Warranty	
<u>GPM - RPM</u>	<u>PSI - TORQUE</u>
15.....	46 2500
18.....	56 3000
20.....	62 3500
25.....	77 3474

H024PD	
Max. Auger Diameter	36"
Min. Hydraulic GPM	20 gpm
Max. Hydraulic GPM	35 gpm
Max. Hydraulic PSI	3250 psi
5 Year Warranty	
<u>GPM - RPM</u>	<u>PSI - TORQUE</u>
20.....	48 2500
24.....	58 3000
26.....	63 3250
30.....	72 4140

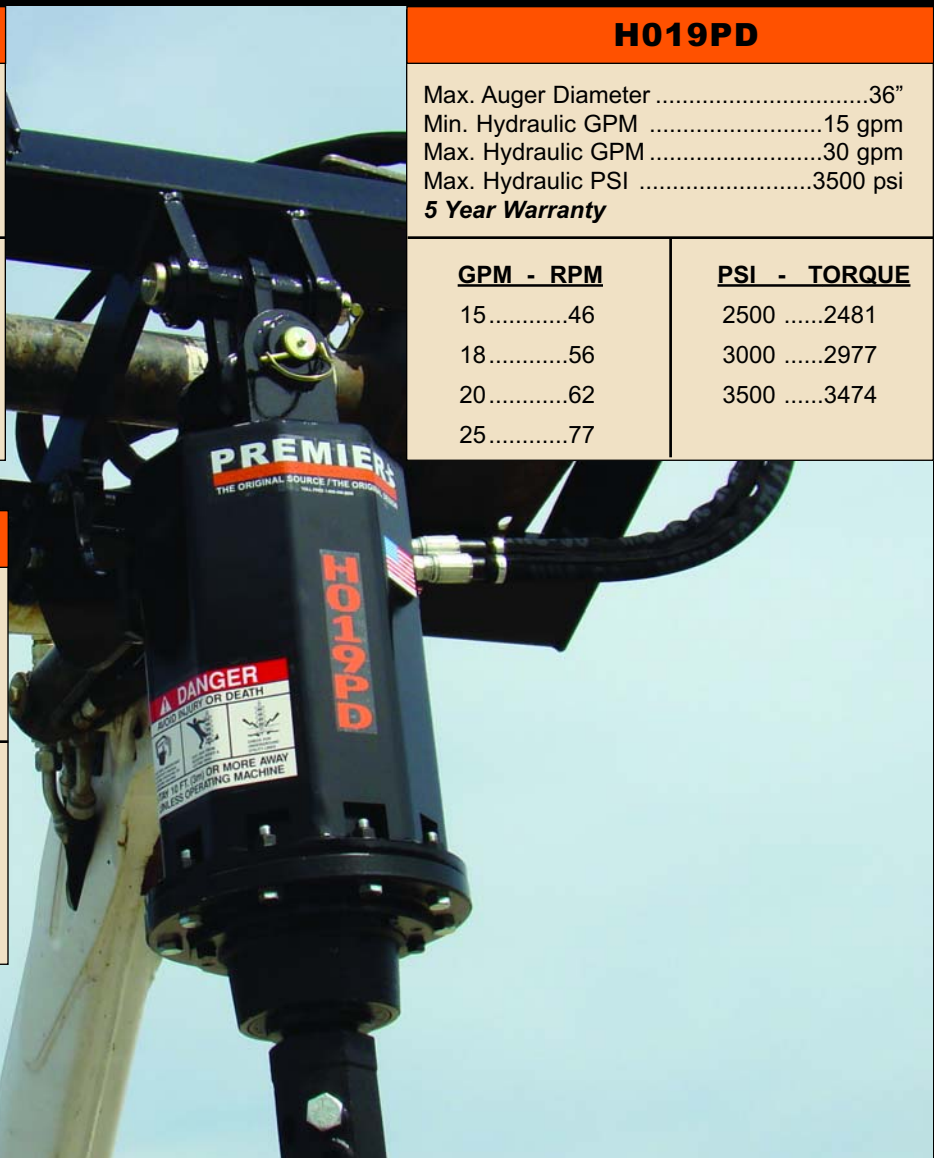

HIGH FLOW AUGER DRIVE UNITS

Backhoes • Articulated Loaders • Tractor Loaders • Integrated Tool Carriers
Telescopic Handlers • Excavators • Boom Cranes • Digger Derricks



H045PD

Max. Auger Diameter48"
Min. Hydraulic GPM25 gpm
Max. Hydraulic GPM45 gpm
Max. Hydraulic PSI4500 psi
No Case Drain Line Required
2" Hex or 2-1/2" Hex Output Shaft
5 Year Warranty

GPM - RPM		PSI - TORQUE	
25	53	2500	3624
30	63	3000	4349
35	74	3500	5074
40	85	4000	5798

H055PD

Max. Auger Diameter48"
Min. Hydraulic GPM30 gpm
Max. Hydraulic GPM60 gpm
Max. Hydraulic PSI4500 psi
No Case Drain Line Required
2" Hex or 2-1/2" Hex Output Shaft
5 Year Warranty

GPM - RPM		PSI - TORQUE	
35	58	2500	4578
40	67	3000	5493
45	75	3500	6409
50	84	4000	7325

H065PD

Max. Auger Diameter48"
Min. Hydraulic GPM30 gpm
Max. Hydraulic GPM60 gpm
Max. Hydraulic PSI4500 psi
No Case Drain Line Required
2" Hex or 2-1/2" Hex Output Shaft
3 Year Warranty

GPM - RPM		PSI - TORQUE	
40	54	2500	5722
45	60	3000	6867
50	67	3500	8011
55	74	4000	9156

H075PD

Max. Auger Diameter48"
Min. Hydraulic GPM30 gpm
Max. Hydraulic GPM60 gpm
Max. Hydraulic PSI4500 psi
No Case Drain Line Required
2-1/2" Hex Output Shaft
3 Year Warranty

GPM - RPM		PSI - TORQUE	
40	43	3000	8527
45	49	3500	9948
50	54	4000	11369
60	65	4500	12790

H085PD

Max. Auger Diameter48"
Min. Hydraulic GPM30 gpm
Max. Hydraulic GPM60 gpm
Max. Hydraulic PSI3500 psi
No Case Drain Line Required
2-1/2" Hex Output Shaft
3 Year Warranty

GPM - RPM		PSI - TORQUE	
40	54	2500	8957
45	39	3000	10748
50	43	3500	12539
60	51		

U144PD-HP

TWO-SPEED / HIGH PRESSURE

Maximum Auger Diameter:48"
Minimum Hydraulic Flow:30 gpm
Maximum Hydraulic Flow:60 gpm
Maximum Continuous Operating PSI:5000 psi
Case Drain Line Required
2 Year Warranty

		3000		4000		5000	
		Ft-Lb Torque / RPM					
		LOW	HIGH	LOW	HIGH	LOW	HIGH
GPM	30	9230 / 25	6070 / 40	12,305 / 25	8095 / 40	15,400 / 25	10,120 / 40
	40	9230 / 33	6070 / 53	12,305 / 33	8095 / 53	15,400 / 33	10,120 / 53
	50	9230 / 42	6070 / 65	12,305 / 42	8095 / 65	15,400 / 42	10,120 / 65

“CDF” MEDIUM DUTY CONSTRUCTION AUGERS

Light to Moderate Ground Conditions



- Fabricated Boring Head
- Hardened Bolt-on Gage Teeth on Outside Positions
- Hardened Bolt-on Wisdom Teeth on Inside Positions
- Hardened Fishtail Point
- Heavy-Duty Double Flighting
- 2" Round, 2-9/16" Round, and 2" Hex Collars
- 4' Standard Length
- Also Available in 3', 5', and 6' Lengths, Upon Request

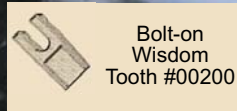

Upgrade and Replacement Parts Listed on Page 10

DIA.	PART#	TOOTH QTY.
04"A04CDF40
06"A06CDF42
08"A08CDF42
09"A09CDF43
10"A10CDF43
12"A12CDF44
15"A15CDF45
16"A16CDF45
18"A18CDF46
20"A20CDF46
24"A24CDF48
30"A30CDF49
36"A36CDF411

4' OVERALL LENGTH

“CDC” HEAVY DUTY CONSTRUCTION AUGERS

Difficult Ground Conditions, Compacted Soils, Heavy Clay, Asphalt, Frozen Ground, Fracturable Rock

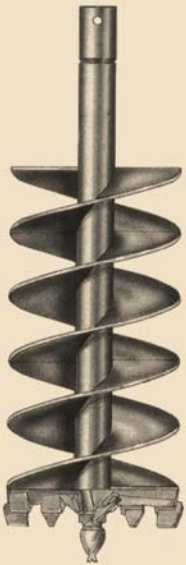

- Heavy-Duty Cast Steel Boring Head
- Hardened Drive-in Gage Teeth on Outside Positions
- Hardened Drive-in Chisel Teeth on Inside Positions
- Hardened Fishtail Point
- Heavy-Duty Double Flighting
- 2" Round, 2-9/16" Round, and 2" Hex Collars
- 4' Standard Length
- Also Available in 3', 5', and 6' Lengths, Upon Request



Upgrade and Replacement Parts Listed on Page 10

DIA.	PART#	TOOTH QTY.
06"A06CDC42
08"A08CDC44
09"A09CDC44
10"A10CDC44
12"A12CDC44
15"A15CDC46
16"A16CDC46
18"A18CDC46
20"A20CDC46
24"A24CDC48
30"A30CDC410
36"A36CDC412
42"A42CDC416
48"A48CDC418

4' OVERALL LENGTH

“CDT” TREE AUGERS

For Tree and Shrub Planting

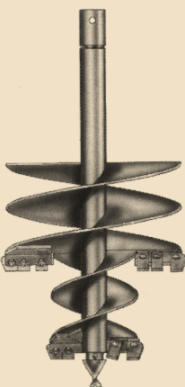

- Two-Diameter Design
- Fabricated Boring Head
- Hardened Bolt-On Gage Teeth on Outside Positions
- Hardened Bolt-On Wisdom Teeth on Inside Positions
- Hardened Fishtail Point
- Heavy-Duty Double Flighting
- 2" Round, 2-9/16" Round, and 2" Hex Collars
- 4' Length Only

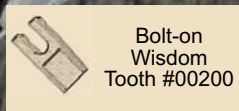
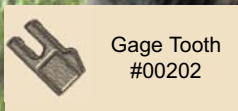

Upgrade and Replacement Parts Listed on Page 10

DIA.	PART#	TOOTH QTY.
18"A18CDT47
24"A24CDT410
30"A30CDT411
36"A36CDT413
42"A42CDT415
48"A48CDT417

4' OVERALL LENGTH

“CDR” BULLET TOOTH ROCK AUGERS

Solid and Fracturable Rock, Compacted Soils, Frozen Ground, Asphalt, Concrete



- Cast Steel Boring Head
- Bullet Style Teeth
- Heavy-Duty Single Fighting
- 3/4" Thick Bottom Flight
- 2" Round, 2-9/16" Round, and 2" Hex Collars
- 4' Length Standard
- Other Sizes Available Upon Request

DIA.	PART#	TOOTH QTY.
06"	A06CDR4	6
09"	A09CDR4	10
12"	A12CDR4	12
16"	A16CDR4	16
18"	A18CDR4	18
20"	A20CDR4	20
24"	A24CDR4	24
30"	A30CDR4	30
36"	A36CDR4	36

4' OVERALL LENGTH



CDR Rock Auger Pilot
1-3/4" Square Shank
00236



CDR Rock Auger
Bullet Tooth
00221

Upgrade and Replacement Parts Listed on Page 10

“CRB” ROCK AUGER

Solid and Fracturable Rock, Compacted Soils, Frozen Ground, Asphalt, Concrete

- Aggressive Carbide Cutting Head
- Heavy-Duty Single Fighting
- 2" Round, 2-9/16" Round, and 2" Hex Collars
- 4" Diameter Only
- 4' Length Standard
- Other Sizes Available Upon Request



DIA.	PART#	TOOTH QTY.
04"	A04CRB4	0



CRB
Rock Auger Pilot
#00239

Upgrade and Replacement Parts
Listed on Page 10

“UDC” UTILITY STYLE AUGERS

For Use on High Torque Drive Unit Models H055PD, H065PD, H075PD, H085PD, U144PD

DIA.	PART#	TOOTH QTY.
09"	A09UDC9	2
12"	A12UDC9	4
16"	A16UDC9	4
18"	A18UDC9	6
20"	A20UDC9	6
24"	A24UDC9	7
30"	A30UDC9	8
36"	A36UDC9	8
42"	A42UDC9	12
48"	A48UDC9	14

- Heavy-Duty Cast Steel Boring Head
- Outside Drive-in Gage Teeth
- Standard or Carbide Teeth & Point
- Heavy-Duty 3/8" Thick Flighting
- Extra Heavy-Duty Center Shaft (3-3/4" Tubing x 5/8" Wall)
- 2-1/2" Hex and 2-5/8" Hex Collars
- 104" Overall Length
- 60" of Flighting
- Special Sizes Available Upon Request



Utility
Gage Tooth
#00214



Utility
Dirt Tooth
#00213



Utility
Fishtail Point
#00217



Carbide Upgrades and Replacement Parts Listed on Page 10

MINI-SKID LOADER EARTH AUGER DRIVE



- **High Torque Unit**
- **Comes with Standard Single-Swing Mount**
- **Optional Full-Swivel Mount**
- **Add Hose Kit and Coupler (listed on page 10)**

H010PDMS

Max. Auger Diameter24"
 Min. Hydraulic GPM.....6 gpm
 Max. Hydraulic GPM15 gpm
 Max. Hydraulic PSI.....3500 psi
 2-9/16" Round Output Shaft
5 Year Warranty

GPM - RPM	PSI - TORQUE
8.....48	25001274
10.....60	30001529
12.....72	35001783
15.....90	

H015PDMS

Max. Auger Diameter30"
 Min. Hydraulic GPM10gpm
 Max. Hydraulic GPM25 gpm
 Max. Hydraulic PSI.....3500 psi
 2-9/16" Round Output Shaft
5 Year Warranty

GPM - RPM	PSI - TORQUE
12.....47	25001977
15.....58	30002372
17.....66	35002768
20.....78	

H019PDMS

Max. Auger Diameter36"
 Min. Hydraulic GPM.....15 gpm
 Max. Hydraulic GPM30 gpm
 Max. Hydraulic PSI.....3500 psi
 2-9/16" Round Output Shaft
5 Year Warranty

GPM - RPM	PSI - TORQUE
15.....46	25002481
18.....56	30002977
20.....62	35003474
25.....77	

MINI-SKID CONSTRUCTION AUGERS

MEDIUM DUTY "CDF" AUGER

- *For Light to Medium Ground Conditions*
- *Fabricated Boring Head*
- *Hardened Bolt-on Wisdom Teeth - Inside Positions*
- *Hardened Bolt-on Gage Teeth - Outside Positions*
- *Hardened Fishtail Point*
- *Heavy-Duty Double Flighting*
- *2" Round, or 2" Hex Collars*
- *42" Overall Length*

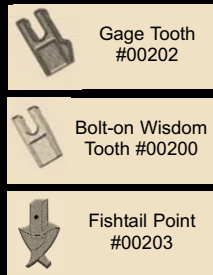

DIA.	PART#	TOOTH QTY.
04"	A04CDF3	0
06"	A06CDF3	2
08"	A08CDF3	2
09"	A09CDF3	3
10"	A10CDF3	3
12"	A12CDF3	4
15"	A15CDF3	5
16"	A16CDF3	5
18"	A18CDF3	6
20"	A20CDF3	6
24"	A24CDF3	8
30"	A30CDF3	9
36"	A36CDF3	11

Upgrade and Replacement Parts Listed on Pg. 10

HEAVY DUTY "CDC" AUGER

- *For Difficult Ground Conditions, Compacted Soils, Heavy Clay, Asphalt, Frozen Ground, Fracturable Rock*
- *Heavy-Duty Cast Steel Boring Head*
- *Hardened Drive-in Gage Teeth - Outside Positions*
- *Hardened Drive-in Chisel Teeth - Inside Positions*
- *Hardened Fishtail Point*
- *Heavy-Duty Double Flighting*
- *2" Round, 2-9/16" Round, or 2" Hex Collars*
- *Standard 42" Overall Length*
- *Also Available in 30" Overall Length*

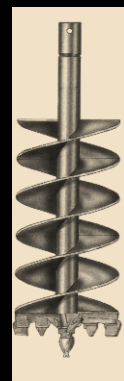

DIA.	PART#	TOOTH QTY.
06"	A06CDC3	2
08"	A08CDC3	4
09"	A09CDC3	4
10"	A10CDC3	4
12"	A12CDC3	4
15"	A15CDC3	6
16"	A16CDC3	6
18"	A18CDC3	6
20"	A20CDC3	6
24"	A24CDC3	8
30"	A30CDC3	10
36"	A36CDC3	12

Upgrade and Replacement Parts Listed on Pg. 10

MOUNTING BRACKETS

Ag Style Equipment

JOHN DEERE 400 / 500 TRACTOR LOADER MOUNT

Available with Off-Set Option

Part # SM019

EURO/UNIVERSAL LOADER MOUNT

Available with Off-Set Option

Part # SM021

TRACTOR LOADER MOUNTS

Attach to lip of loader bucket or arm.

Part # TM001

Construction Equipment

EXCAVATOR & BACKHOE MOUNTS



- Case 580/590 Pin-On # BH001
- John Deere 310/410/510 Pin-On.....# BH002
- John Deere 310SE/410SE Pin-On# BH006
- Caterpillar 416/426/428/436 Pin-On# BH003
- New Holland 400/500/600/700 Series Pin-On .. # BH004
- JCB 1400/1700 Pin-On # BH005
- Pin Grabber Mounting AssembliesCall Factory
- Backhoe & Excavator Quick Coupler Mounts
.....Call Factory
- Excavator Mounts with Pins up to
4" & Dipper Width up to 18".....CUSTOM

MINI EXCAVATOR MOUNTS

.....Call Factory

Construction Equipment (cont.)



UNIVERSAL SKID STEER MOUNT

Part # SM001
SAE J2513



OFF-SET UNIVERSAL SKID STEER MOUNT

Part # SM020

HIGH REACH MOUNT EXTENSION

Hooks up to any
Universal Skid Steer
Mount for increased
digging depth.

Part # SMEX01

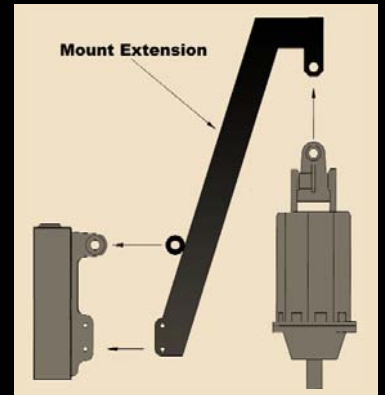

Skid Steer Mounts include required hardware and pins to attach to Premier Earth Auger Drives, complete with swivel, knuckle, auger drive, cradle, and connecting pins (greaseable and contained with snap pins).

NOTE: Connection points have machined 4140 alloy hardened bushings.

Contact factory for information on mounting brackets for older model skid steer loaders.

MOUNTING ADAPTERS

HEAVY DUTY WELD-ON ADAPTER

Welds to any implement and mounts on Universal Skid Steer Mount.

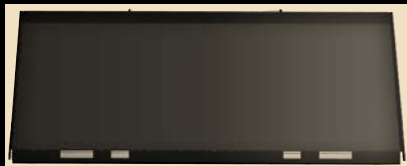

- 5/16" steel plate# 95009
- 3/8" steel plate.....# 95021

SKID STEER MOUNT CRADLE

Part # 91003

KNUCKLE WELDMENT

For Customer Made Mounts

Part # 91002

AUGER EXTENSIONS

VARIABLE LENGTH AUGER EXTENSIONS

Variable Length Auger Extensions store inside the tube of augers that are 10" diameter or larger. Extension increments are every six inches on 12" through 24" extensions and every twelve inches on 48" and 72" extensions. Available with 2" and 2-9/16" Round, and 2", 2-1/2" and 2-5/8" Hexagon Collars. Special Extensions are available and priced upon request.

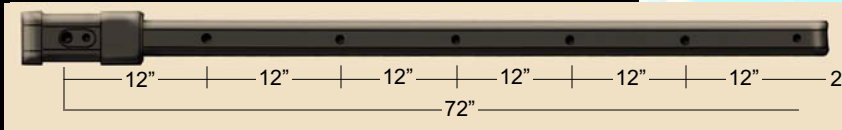

- 2" Rnd Variable Extension 12" LongCVE12R200
- 2" Hex Variable Extension 12" LongCVE12H200
- 2-9/16" Variable Extension 12" LongCVE12R256
- 2" Rnd Variable Extension 24" LongCVE24R200
- 2" Hex Variable Extension 24" LongCVE24H200
- 2-9/16" Variable Extension 24" LongCVE24R256
- 2" Rnd Variable Extension 48" LongCVE48R200
- 2" Hex Variable Extension 48" LongCVE48H200
- 2-9/16" Variable Extension 48" LongCVE48R256
- 2" Rnd Variable Extension 72" LongCVE72R200
- 2" Hex Variable Extension 72" LongCVE72H200
- 2-9/16" Variable Extension 72" LongCVE72R256
- 2-1/2" Hex Variable Extension 72" Long ..UVE72H250
- 2-5/8" Hex Variable Extension 72" Long ..UVE72H262

FIXED LENGTH AUGER EXTENSIONS

Fixed Length Auger Extensions extend the auger's digging depth exactly the length of the extension. Available with 2" and 2-9/16" Round, and 2", 2-1/2" and 2-5/8" Hexagon Collars. Special Extensions are available and priced upon request.

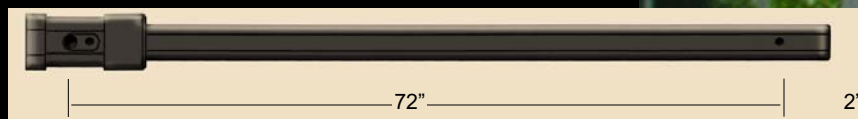

- 2" Rnd Fixed Extension 12" LongCFE12R200
- 2" Hex Fixed Extension 12" LongCFE12H200
- 2-9/16" Fixed Extension 12" LongCFE12R256
- 2" Rnd Fixed Extension 24" LongCFE24R200
- 2" Hex Fixed Extension 24" LongCFE24H200
- 2-9/16" Fixed Extension 24" LongCFE24R256
- 2" Rnd Fixed Extension 48" LongCFE48R200
- 2" Hex Fixed Extension 48" LongCFE48H200
- 2-9/16" Fixed Extension 48" LongCFE48R256
- 2" Rnd Fixed Extension 72" LongCFE72R200
- 2" Hex Fixed Extension 72" LongCFE72H200
- 2-9/16" Fixed Extension 72" LongCFE72R256
- 2-1/2" Hex Fixed Extension 72" LongUFE72H250
- 2-5/8" Hex Fixed Extension 72" LongUFE72H262



ADAPTERS FOR DRIVE UNITS & AUGERS

- 2" Hex Female To 2-9/16" Rnd Male AdapterC200H256R
- 2" Hex Female To 2" Rnd Male AdapterC200H200R
- 2-9/16" Rnd Female To 2" Hex Male AdapterC256R200H
- 2-9/16" Rnd Female To 2" Rnd Male AdapterC256R200R
- 2" Rnd Female To 2" Hex Male AdapterC200R200H
- 2" Rnd Female To 2-9/16" Rnd Male AdapterC200R256R

Couple Premier Drive Units to competitive augers or Premier Augers to competitive drive units. Determine the drive unit output shaft and collar opening sizes and types (round or hexagon) to select the proper adapter. Special Adapters are available and priced upon request.

ACCESSORIES AND REPLACEMENT WEAR PARTS

When pricing a complete Hydraulic Earth Auger Attachment for your machine, include the following:

- Hydraulic Drive Unit
- Hoses and Fittings
- Mounting Bracket
- Auger
- Optional Auger Upgrades and Accessories
- Spare Replacement Wear Parts

TEETH & POINTS

CONSTRUCTION AUGER TEETH

Wisdom Tooth	#00200
Chisel Tooth	#00201
Wisdom Gage Tooth	#00202
Hardfaced Wisdom Tooth.....	#00205
Hardfaced Chisel Tooth	#00206
Hardfaced Wisdom Gage Tooth	#00207
Carbide Wisdom Tooth.....	#00208
Carbide Chisel Tooth	#00209
RB Carbide Wisdom Tooth	#00237
Tooth Pocket for CDC Augers	#00225
Rock Auger Bullet Tooth	#00221
Bullet Tooth Holder.....	#00223
5/8"-11 Carriage Bolt 1-1/2" Long	#40000
5/8"-11 Lock Nut	#40001

CONSTRUCTION AUGER PILOT POINTS

Fishtail Point	#00203
Hardfaced Fishtail Point.....	#00210
Carbide Fishtail Point	#00211
4-1/2" Auger Fishtail Point.....	#00204
Square Drive Lug	#00105
4" Auger Drive Lug	#00106
CDR Rock Auger Pilot -	
- with 1-3/4" Square Shank	#00236
- with 2-3/8" API.....	#00222
CDR Rock Auger Bullet Tooth	#00221
CRB Rock Auger Fishtail Point	#00239

HOSES & FITTINGS

1/2" Hydraulic Hoses 68" Long	#61061
1/2" Hydraulic Hoses 108" Long	#61050
1/2" Hydraulic Hoses 120" Long	#61049
1/2" Female Flat Faced Coupler	#61006
1/2" Male Flat Faced Coupler	#61007
3/4" Hydraulic Hose Kit 108" Long	#61051
3/4" Female Flat Faced Coupler	#61043
3/4" Male Flat Faced Coupler	#61044

AUGER COLLARS

2" Hex Auger Collar	#00102
2-9/16" Round Auger Collar	#00101
2" Round Auger Collar	#00100
2-1/2" Hex Collar	#00103
2-5/8" Hex Collar	#00104

MISCELLANEOUS WEAR PARTS

Knuckle Pin	#91001
Drive Unit Housing.....	#91000

UTILITY AUGER TEETH

Utility Dirt Tooth	#00213
Utility Gage Tooth	#00214
Utility Carbide Dirt Tooth	#00215
Utility Carbide Gage Tooth.....	#00216

UTILITY AUGER PILOT POINTS

Utility Fishtail Point	#00217
Utility Hardfaced Fishtail Point	#00218
Utility Carbide Fishtail Point	#00219
Utility Drive Lug	#00220
Utility Pilot Adapter	#00224

PREMIER 

THE ORIGINAL SOURCE / THE ORIGINAL DESIGN

1631 East Pontiac Street

Fort Wayne, IN 46803

Toll Free: 1-866-458-0008

Phone: 260-456-8518

Fax: 260-456-6868

E-mail: greg@premierauger.com

www.premierauger.com